

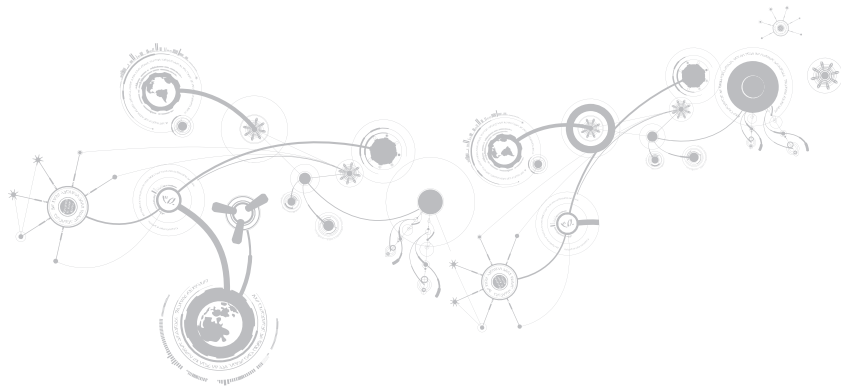



# ALIENWARE® M11x MOBILE MANUAL



## Notes, Cautions, and Warnings

-  **NOTE:** A NOTE indicates important information that helps you make better use of your computer.
-  **CAUTION:** A CAUTION indicates either potential damage to hardware or loss of data and tells you how to avoid the problem.
-  **WARNING:** A WARNING indicates a potential for property damage, personal injury, or death.

The contents herein are subject to change without notice.

© 2010 Dell Inc. All rights reserved.

Reproduction of these materials in any manner whatsoever without the prior written permission of Dell Inc. is strictly prohibited.

Trademarks used in this manual: *Alienware*, *AlienFX*, and the *AlienHead* logo are trademarks or registered trademarks of Alienware Corporation; *Dell* is a trademark of Dell Inc.; *Microsoft* and *Windows* are either trademarks or registered trademarks of Microsoft Corporation in the United States and/or other countries; *Intel* and *SpeedStep* are registered trademarks and *Core* is a trademark of Intel Corporation in the U.S. and other countries; *Bluetooth* is a registered trademark owned by Bluetooth SIG, Inc; *Absolute* is a registered trademark of Absolute Software Corporation.

Other trademarks and trade names may be used in this manual to refer to either the entities claiming the marks and names or their products. Dell Inc. disclaims any proprietary interest in trademarks and trade names other than its own.

**Regulatory model:** P06T      **Regulatory type:** P06T001/P06T002

**P/N:** 7XM1F      **Rev.** A00      **April 2010**

# CONTENTS

<b>CHAPTER 1: SETTING UP YOUR LAPTOP</b> .....	<b>9</b>
Before Setting Up Your Laptop .....	10
Connect the AC Adapter .....	12
Press the Power Button .....	13
Connect the Network Cable (Optional) .....	14
Set Up Microsoft Windows .....	15
Connect to the Internet (Optional) .....	16
<b>CHAPTER 2: GETTING TO KNOW YOUR LAPTOP</b> .....	<b>19</b>
Left View Features .....	20
Right View Features .....	24
Back View Features .....	25
Display Features .....	26
Computer Base and Keyboard Features .....	28
Power Button .....	30
Function Keys .....	32

## CONTENTS

<b>CHAPTER 3: USING YOUR LAPTOP</b> .....	<b>35</b>
Alienware Command Center.....	36
Using Removable Media and Cards.....	39
Using the Wireless Control.....	40
Battery Pack.....	40
Power Management.....	41
nVidia Optimus Technology.....	43
Configuring the BIOS.....	45
<b>CHAPTER 4: INSTALLING AND REPLACING COMPONENTS</b> .....	<b>55</b>
Before You Begin.....	56
Replacing the Battery Pack.....	60
Upgrading or Replacing Memory.....	63
Upgrading or Replacing the Hard Drive Assembly.....	66
<b>CHAPTER 5: TROUBLESHOOTING</b> .....	<b>71</b>
Basic Hints and Tips.....	72
Backup and General Maintenance.....	73
Software Diagnostic Tools.....	75
Answers to Common Problems.....	78

<b>CHAPTER 6: SYSTEM RECOVERY</b> .....	<b>85</b>
Recovery Options .....	86
Dell DataSafe Local Backup .....	87
<b>CHAPTER 7: SPECIFICATIONS</b> .....	<b>91</b>
<b>APPENDIX</b> .....	<b>105</b>
GENERAL AND ELECTRICAL SAFETY PRECAUTIONS .....	106
CONTACTING ALIENWARE .....	109



Dear Valued Alienware Customer,

Welcome to the Alienware family. We are thrilled to include you among the growing number of savvy high-performance mobile users.

The Alienware technicians who have crafted your machine have made certain that your high-performance mobile is properly optimized and performs to its fullest potential. We build machines with one single unwavering purpose: Build It As If It Were Your Own. The technicians will not rest until your new machine meets or exceeds our very demanding criteria!

We have tested your machine extensively in order to ensure that you enjoy the highest levels of performance. In addition to a standard burn-in period, your system has been evaluated using real-world tools such as synthetic performance benchmarks.

We invite you to share your experience with your new high-performance mobile with us, so please do not hesitate to either e-mail or call Alienware with any questions or concerns. The entire staff shares your enthusiasm for new technology and we hope that you enjoy using your new mobile as much as Alienware enjoyed building it for you.

Sincerely,

Alienware Staff





አዲስ አበባ ፎካል ስኬት ኮሌጅ

# CHAPTER 1: SETTING UP YOUR LAPTOP



# Before Setting Up Your Laptop

### **Congratulations on the purchase of your Alienware® M11x!**

Read all safety and setup instructions before connecting your new laptop. Begin by carefully opening the box and removing all components that were shipped to you.

Before setting up your laptop or components, see the included invoice to verify that all items ordered are present and be sure to inspect all items for any physical damage that may have occurred during shipment. Report any missing components or damaged items to customer service within 5 days of receiving the shipment. Anything reported missing or damaged after the first 5 days of receiving a shipment will not be honored. Some of the most common items to check for include:

- Laptop and AC adapter with power cable
- Microsoft CD-key located at the bottom of the laptop
- Monitor with power cable and video cable (if ordered)
- Keyboard (if ordered)
- Mouse (if ordered)
- Multimedia speakers and sub-woofer (if ordered)
- Joystick controllers (if ordered)

You may also need a small flathead and/or a Phillips head screwdriver for connecting peripheral cables to the laptop.

## Product Documentation and Media

The documentation that ships with your Alienware® laptop is designed to provide answers to many of the questions that may arise as you explore your new laptop's capabilities. You may see the documentation for technical information or general use as needed to answer questions in the future, or aid you in finding answers and solutions. The media included with your laptop is referenced in some sections of the documentation and may be needed to complete certain tasks. As always, our technical support staff is available to assist you.

## Placing Your Laptop

 **WARNING: Do not place the laptop near or over a radiator or heating vent. If your laptop is placed in a cabinet, ensure that adequate ventilation is provided. Do not place the laptop in a humid location or in any area where the laptop may be exposed to rain or water. Be careful not to spill liquid of any kind on or into the laptop.**

When placing your laptop, ensure that:

- It is placed on a surface that is both level and stable.
- The power and other cable connectors are not jammed between the laptop and a wall – or any other object.
- Nothing obstructs airflow in front of, behind, or below the laptop.
- The laptop has enough room so that optical drives and other external storage drives can be easily accessed.

## Connect the AC Adapter

-  **WARNING:** The AC adapter works with electrical outlets worldwide. However, power connectors and power strips vary among countries. Using an incompatible cable or improperly connecting the cable to a power strip or electrical outlet may cause fire or equipment damage.

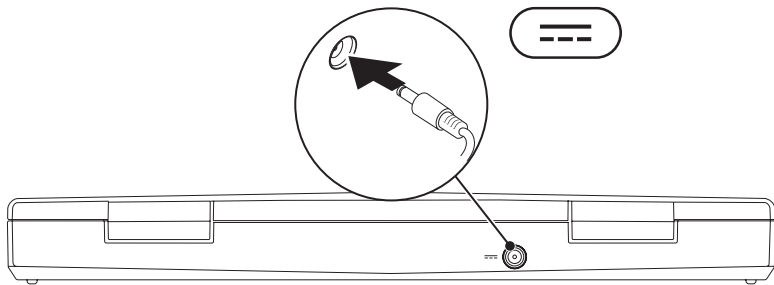

## Press the Power Button

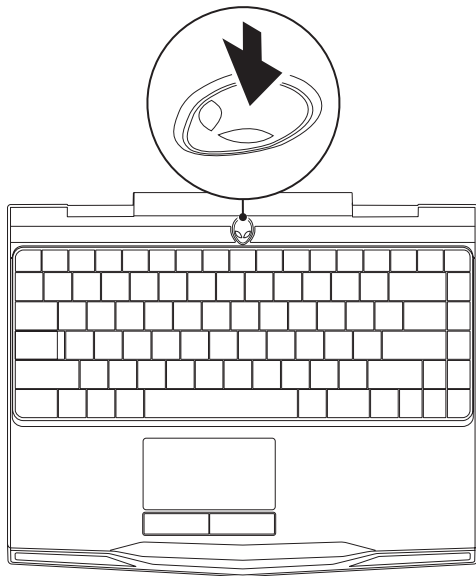

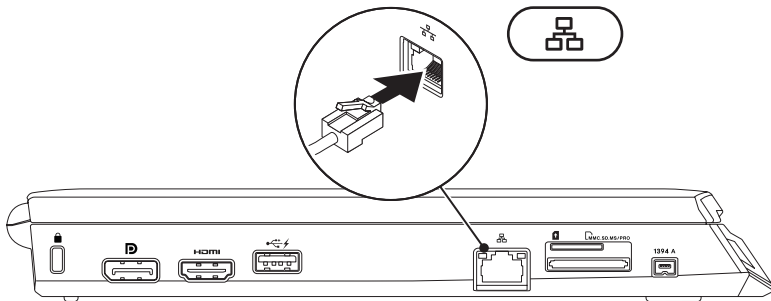

## Connect the Network Cable (Optional)





## Set Up Microsoft Windows

Your computer is preconfigured with the Microsoft® Windows® operating system. To set up Windows for the first time, follow the instructions on the screen. These steps are mandatory and may take some time to complete. The Windows setup screens will take you through several procedures including accepting license agreements, setting preferences, and setting up an Internet connection.

 **CAUTION:** Do not interrupt the operating system's setup process. Doing so may render your computer unusable and you will need to reinstall the operating system.

 **NOTE:** For optimal performance of your computer, it is recommended that you download and install the latest BIOS and drivers for your computer available at [support.dell.com](http://support.dell.com).

 **NOTE:** For more information on the operating system and features, see [support.dell.com/MyNewDell](http://support.dell.com/MyNewDell).

 **NOTE:** It is recommended that you create a full system backup as soon as you set up Microsoft Windows. To create a full system backup, see "Dell DataSafe Local Backup" on page 87.

## Connect to the Internet (Optional)

### Setting Up a Wired Connection

- If you are using a dial-up connection, connect the telephone line to the optional external USB modem and to the telephone wall jack before you set up your Internet connection.
- If you are using a DSL or cable/satellite modem connection, contact your ISP or cellular telephone service for setup instructions.

To complete setting up your wired Internet connection, follow the instructions in “Setting Up Your Internet Connection” on page 18.



## Setting Up a Wireless Connection

 **NOTE:** To set up your wireless router, see the documentation that shipped with your router.

Before you can use your wireless Internet connection, you need to connect to your wireless router.

To set up your connection to a wireless router:

1. Ensure that wireless is enabled on your computer.
2. Save and close any open files, and exit any open programs.
3. Click **Start**  → **Control Panel**.
4. In the search box, type `network`, and then click **Network and Sharing Center** → **Connect to a network**.
5. Follow the instructions on the screen to complete the setup.

### Setting Up Your Internet Connection

ISPs and ISP offerings vary by country. Contact your ISP for offerings available in your country.

If you cannot connect to the Internet but have successfully connected in the past, the Internet Service Provider (ISP) might have a service outage. Contact your ISP to check the service status, or try connecting again later.

Have your ISP information ready. If you do not have an ISP, the **Connect to the Internet** wizard can help you get one.

1. Save and close any open files, and exit any open programs.
2. Click **Start**  → **Control Panel**.
3. In the search box, type `network`, and then click **Network and Sharing Center** → **Set up a new connection or Network** → **Connect to the Internet**.

The **Connect to the Internet** window appears.

-  **NOTE:** If you do not know which type of connection to select, click **Help me choose** or contact your ISP.
4. Follow the instructions on the screen and use the setup information provided by your ISP to complete the setup.

አሁን ለምሳሌ ለምሳሌ ለምሳሌ  
አሁን ለምሳሌ ለምሳሌ ለምሳሌ

## CHAPTER 2: GETTING TO KNOW YOUR LAPTOP





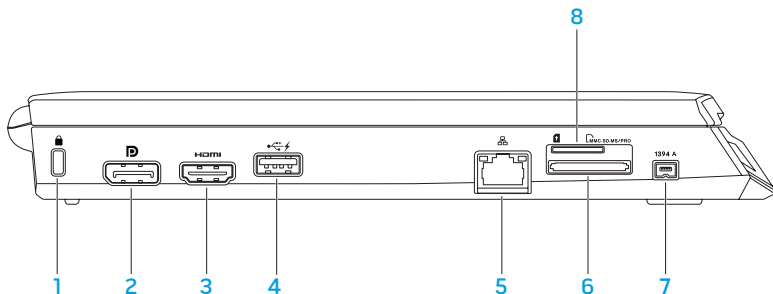

## CHAPTER 2: GETTING TO KNOW YOUR LAPTOP

This chapter provides information about your new laptop to familiarize you with its various features, and get you up and running quickly.

### Left View Features



-  **Security cable slot** — Attaches a commercially available security cable to the computer.  
**NOTE:** Before you buy a security cable, ensure that it fits into the security cable slot on your computer.
-  **DisplayPort connector** — Connects your computer to external monitors and projectors with DisplayPort.
-  **HDMI connector** — Connects to a TV for both multi-channel digital audio and video signals.  
**NOTE:** For a monitor without built-in speakers, only the video signal will be read.



- 4  **USB connector with USB PowerShare** — Connects to USB devices, such as a mouse, keyboard, printer, external drive, or MP3 player.

The USB Powershare feature allows you to charge USB devices when the computer is powered on/off or in sleep state.

**NOTE:** Certain USB devices may not charge when the computer is powered off or in sleep state. In such cases, turn on the computer to charge the device.



**NOTE:** The USB PowerShare is automatically shut off when only 10% of the total battery life remains.

- 5  **Network connector** — Connects your computer to a network or broadband device.

- 6  **3-in-1 Media Card Reader** — Provides a fast and convenient way to view and share digital photos, music, videos, and documents.
- 7  **IEEE 1394 A connector** — Connects to high-speed serial multimedia devices such as digital video cameras.
- 8 **SIM card slot** — Allows you to install a Subscriber Identity Module (SIM) to browse the Internet, check e-mail, and connect to a Virtual Private Network. To access the Internet, you must be within the network of your cellular service provider.

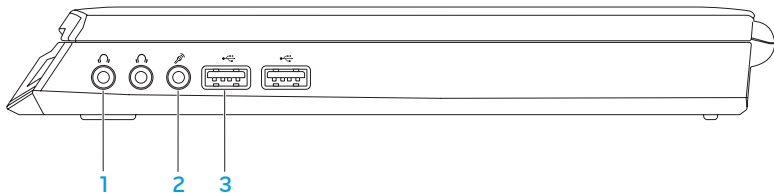
## Right View Features



-  **Audio out/Headphone connectors (2)** — Connect to a pair of headphones or to a powered speaker or sound system.
-  **Audio in/Microphone connector** — Connects to a microphone or inputs signal for use with audio programs.
-  **USB connectors (2)** — Connect to USB devices, such as a mouse, keyboard, printer, external drive, or MP3 player.



## Back View Features

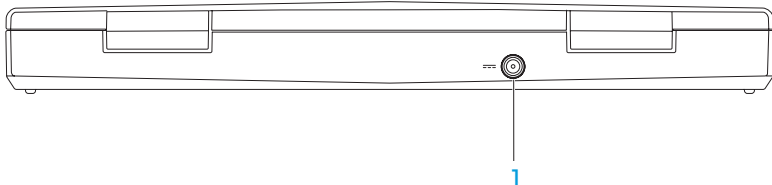

-  **AC adapter connector** — Connects to an AC adapter to power the computer and charge the battery.

## Display Features

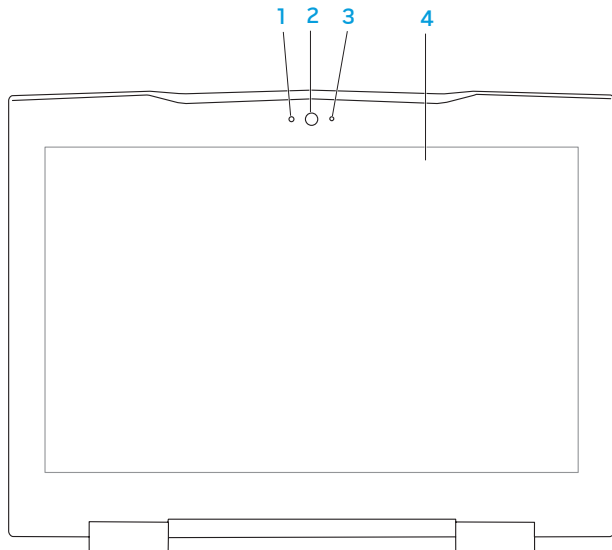

- 1 **Microphone** — Provides high quality sound for video conferencing and voice recording.
- 2 **Camera** — Built-in camera for video capture, conferencing, and chat.
- 3 **Camera activity indicator** — Indicates if the camera is on or off.
- 4 **Display** — Your display can vary based on selections you made when purchasing your computer. For more information about displays, see the *Dell Technology Guide* available on your hard drive or at [support.dell.com/manuals](https://support.dell.com/manuals).

## Computer Base and Keyboard Features

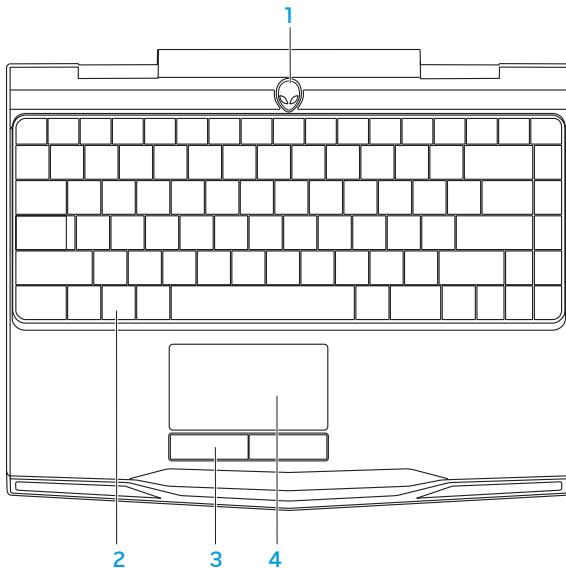

- 1 **Power button** — Turns the computer on or off when pressed. For more information, see “Power Button” on page 30.
- 2 **Keyboard** — The backlit keyboard provides visibility in dark environments by illuminating all symbols on the keys.
- 3 **Touch pad buttons (2)** — Provide left- and right-click functions like those on a mouse.
- 4 **Touch pad** — Provides the functionality of a mouse to move the cursor, drag or move selected items, and left-click by tapping the surface.

# Power Button

You can program this button to perform actions like shutting down the operating system or entering the standby mode. For details on how to program this button, see **Power Options** in the control panel of Microsoft® Windows® operating system.

The power button is located in the center of the hinge cover. For the exact location, see “Computer Base and Keyboard Features” on page 28.

The color of the AlienHead rim indicates the power status. The color indicating the power status can be changed through the AlienFX® software.



### On AC adapter:

Blue or custom AC-color

The battery is fully charged.

Blue or custom AC-color fading into white or custom battery-color

The computer is turned off or on and the battery is charging.

Blue or custom AC-color fading into black

The computer is in standby mode.

### On battery:

Amber or custom battery-color

The battery is fully charged.

Amber or custom battery-color fading into black

The computer is in standby mode.

Blinking Amber or custom battery-color

The battery charge is low.

For more details on standby and hibernate mode, see **Power Options** in the control panel of your Microsoft Windows operating system.

# Function Keys

 **NOTE:** Depending on the configuration of the laptop you purchased, some of the function keys may have no associated tasks.

The <Fn> key is located near the bottom-left corner of the keyboard, and is used together with other keys to activate certain functions. Hold down the <Fn> key along with the key described below:



### F1 — Extend Desktop

Press <Fn><F1> to switch between the various external display options available either simultaneously or separately.



### F2 — Check Battery Status

Press <Fn><F2> to display the Battery Status Meter.



### F3 — Wireless Control - Switch wireless communications on/off

Press <Fn><F3> to enable or disable the wireless function.



### F4 — Increase Display Brightness

Press <Fn><F4> to increase the brightness of the display.



**F5 — Decrease Display Brightness**

Press <Fn><F5> to decrease the brightness of the display.

**F7 — Mute on/off**

Press <Fn><F7> to enable or disable the mute function.

**F8 — Decrease volume**

Press <Fn><F8> to decrease the volume level.

**F9 — Increase volume**

Press <Fn><F9> to increase the volume level.

**F10 — Rewind or Play previous track**

Press <Fn><F10> to rewind or play previous track.

**F11 — Play or Pause**

Press <Fn><F11> to play or pause a track.

**F12 — Fast Forward or Play next track**

Press <Fn><F12> to fast forward or play the next track.

## CHAPTER 2: GETTING TO KNOW YOUR LAPTOP



### PAUSE — Alienware Command Center

Press <Fn><PAUSE> to access Alienware Command Center (for more information, see “Alienware Command Center” on page 36).



### PRT SCR N — AlienFX

Press <Fn><PRT SCR N> to enable or disable the AlienFX illumination.

AlienFX facilitates control of your computer's lighting by creating a theme that contains all of your lighting choices.

የግለሰብ ግብይት ስርዓት

## CHAPTER 3: USING YOUR LAPTOP



# Alienware Command Center

The Alienware® Command Center gives you access to Alienware's exclusive software and is a continuously upgradable control panel. As Alienware releases new programs, they download directly into the Command Center allowing you to build a library of system management, optimization, and customization tools. You can access Alienware Command Center by pressing <Fn><PAUSE>.









## Connecting External Displays

If you want to enjoy your computing environment on a bigger scale visually, or extend your desktop area, you can connect an external display such as a standalone monitor, an LCD TV, or a projector.

### Connecting a Display

Use the appropriate cable based on the connectors available on your computer and display. Refer to the following table to identify the connectors on your computer and display.

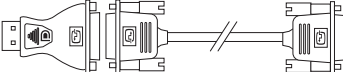
 **NOTE:** When connecting to a single display, connect the display to **ONLY ONE** of the connectors on your computer.

Connection Type	Computer	Cable	Display
HDMI-to-HDMI (HDMI cable)			
DisplayPort-to-DisplayPort (DisplayPort cable)			
DisplayPort-to-DVI (DisplayPort-to-DVI adapter + DVI cable)			



**NOTE:** You can purchase the DisplayPort-to-DVI adapter and additional HDMI cables at [www.dell.com](http://www.dell.com).

## CHAPTER 3: USING YOUR LAPTOP

1. Turn off your laptop.
2. Turn off the display and disconnect it from the power supply.
3. Connect one end of the display cable to the DisplayPort, or HDMI connector on your Alienware laptop.
4. Connect the other end of the cable to the same connector on your display.
5. If necessary, connect one end of the power cable to the display's power connector.
6. Connect the other end of the power cable to a grounded three-prong power strip or wall outlet.
7. Turn on your laptop, and then turn on your display.

## Extending the Desktop

1. With the external display connected, right-click on the desktop and select **Personalize**.
2. Select **Connect to a projector or other external display** in the upper left portion of the screen.
3. Click **Connect Display**.
4. Select from the below options that appear on the screen:
  - **Duplicate my display on all displays (mirrored)**
  - **Show different parts of my desktop on each display (extended)**
  - **Show my desktop on the external display only**
5. Click **Apply** to apply your changes and then click **OK** to exit the Display Settings control panel.

## Using Removable Media and Cards

Observe the safety measures below:

When no media card (SD/MMC/MS cards) is inserted into the media card slot, ensure that the blank cards that shipped with your laptop is inserted in the unused slot(s). The blank cards protect the unused slots from dust and other particles. When inserting a blank card, ensure that the correct side is on the top (indicated by an arrow mark on some blank cards). Inserting a blank card upside down may damage your laptop.

# Using the Wireless Control

The wireless control allows you to quickly turn all of your wireless radios (Bluetooth® and WLAN) off, such as when you are asked to disable all wireless radios on an airplane flight. Press <Fn><F3> to turn on all radios. Pressing <Fn><F3> again returns your wireless radios to their respective states they were in before you pressed <Fn><F3> the first time.

# Battery Pack

Your laptop is equipped with a high-energy rechargeable lithium ion prismatic (Li-ion) battery pack. Battery life will vary depending on your laptop configuration, model, applications installed, power management settings, and features used. As with all batteries, the maximum capacity of this battery will decrease with time and usage.

The battery meter lights on the battery pack indicate the charge level of the battery. When you press the battery meter once, the charge level lights illuminate. Each of the five lights represent approximately 20% of the total battery charge. For example, if four lights turn on, there is 80% of battery charge remaining and if no lights turn on, there is no charge remaining in the battery.



# Power Management

## Understanding Power Consumption

In order to fully utilize the power of your battery, it would be a good idea for you to spend some time acquiring a basic understanding of the power management concept from your operating system.

You can use the power options in your operating system to configure the power settings on your computer. The Microsoft® Windows® operating system installed on your computer provides three default options:

- **Balanced** — Offers full performance when you need it and saves power during periods of inactivity.
- **Power Saver** — Saves power on your computer by reducing system performance to maximize the life of the computer and by reducing the amount of energy consumed by your computer over its lifetime.
- **High Performance** — Provides the highest level of system performance on your computer by adapting processor speed to your activity and by maximizing system performance.

# Customizing Your Power Settings

1. Click **Start**  → **Control Panel**.
2. Click **All Control Panel Items**.
3. Double-click the **Power Options** icon.
4. Select a power plan from the options shown. To customize specific settings, click **Change plan settings** next to the selected power plan.

## Reducing Power Consumption

Although your laptop (together with the operating system) is capable of power conservation, there are measures you can take to reduce the power consumption:

- Use the AC power whenever possible.
- Lower the intensity of the display backlight. A very bright screen translates to higher power usage.
- Use the **Go Dark** mode in the Alienware command centre.

## nVidia Optimus Technology

Your Alienware M11x laptop is equipped with nVidia's Optimus technology. The Optimus technology is designed to maximize performance and user experience on your computer, while minimizing the impact on battery life. It enables you to combine the graphic processing capability of the integrated Intel® graphic processing unit (GPU) with the discrete nVidia GPU while running graphic-intensive applications such as 3-D games. The nVidia GPU is turned on only for preset applications and thus extends the battery life.

The Optimus solution is enabled through an application profile. When an application is launched, the video drivers check to see if the application has an application profile associated with it.

- If an application profile exists, the nVidia GPU is turned on and the application runs in performance mode. The nVidia GPU is turned off automatically when the application is closed.
- If an application profile does not exist, the integrated Intel GPU is used.

The default list of application profiles is updated frequently by nVidia and is automatically downloaded to your computer when you are connected to the internet.

You can also create application profiles for any application on your computer. This may be required for newly released games or applications that do not have a default application profile.

## Changing the Application Profile Settings

1. Right-click on the desktop and select **NVIDIA Control Panel**.
2. In the **NVIDIA Control Panel** window, click **3D Settings** to expand the selection (if not already expanded) and then click **Manage 3D Settings**.
3. In the **Program Settings** tab, click **Add** and browse to select the application's executable file (.exe). Once added, you can change the settings for that application.

To change the settings for a specific application, locate the application in the **Select a program to customize:** list and make the desired changes.

 **NOTE:** For more information on the nVidia control panel's options and settings, click **Help**.

# Configuring the BIOS

## System Setup

The System Setup options allow you to:

- Change the system configuration information after you add, change, or remove any hardware in your laptop.
- Set or change a user-selectable option.
- View the installed amount of memory or set the type of hard drive installed.

Before you use System Setup, it is recommended that you write down the current System Setup information for future reference.

 **CAUTION: Do not change the settings in System Setup unless you are an expert computer user. Certain changes can cause your computer to work incorrectly.**

### Entering System Setup

1. Turn on (or restart) your laptop.

 **NOTE:** Keyboard failure may result when a key on the keyboard is held down for extended periods of time. To avoid possible keyboard failure, press and release <F2> in even intervals until the System Setup screen appears.

2. While the laptop is booting, press <F2> immediately before the operating system logo appears to access the **BIOS Setup Utility**.

If an error occurs during POST (Power On Self Test), you may also enter the **BIOS Setup Utility** by pressing <F2> when prompted.



 **NOTE:** If you wait too long and the operating system logo appears, continue to wait until you see the Microsoft® Windows® desktop, then shut down your laptop and try again.

### System Setup Screens

The **BIOS Setup Utility** window displays current or changeable configuration information for your laptop. Information is divided into five menus: **Main**, **Advanced**, **Security**, **Boot**, and **Exit**.

Key functions appear at the bottom of the **BIOS Setup Utility** window and lists keys and their functions within the active field.

## System Setup Options

-  **NOTE:** Depending on your computer and installed devices, the items listed in this section may not appear, or may not appear exactly as listed.
-  **NOTE:** For the updated system setup information, see the *Service Manual* at **support.dell.com/manuals**.

### Main Menu

---

System Time	Displays the system time.
System Date	Displays the system date.
Alienware	Displays the model number of your computer.
Service Tag	Displays the service tag of your computer.
BIOS Version	Displays the BIOS version.
EC Version	Displays the EC firmware version.
ME version	Displays the Intel® ME firmware version.
CPU	Displays the type of processor installed.
CPU Frequency	Displays the speed of the processor.
CPU L3 Cache	Displays the processor cache size.

### Main Menu

---

CPU ID	Displays the ID of the processor.
Total Memory	Displays the total memory available in your computer.
Memory Bank 0	Displays the memory size installed in DIMM 0.
Memory Bank 1	Displays the memory size installed in DIMM 1.

### Advanced Menu

---

Intel SpeedStep®	Allows you to enable or disable the Intel SpeedStep technology. Disabling this feature may improve performance, but will greatly reduce battery life.
Use XD Capability	Allows you to enable or disable the Intel eXecute Disable bit.
USB Emulation	Allows you to enable or disable the USB emulation feature. This feature defines how the BIOS, in the absence of a USB-aware operating system, handles USB devices. USB emulation is always enabled during POST (Power On Self Test).

**NOTE:** You cannot boot any type of USB device (floppy, hard drive, or memory key) when this option is off.



## Advanced Menu

---

### USB Wake Support

Allows you to enable USB devices to wake the computer from standby or to disable the USB wake support feature.

**NOTE:** If USB Powershare is enabled, a device connected to the USB Powershare connector may not wake the computer.

### IEEE 1394

Allows you to enable or disable the IEEE 1394 A connector.

- Disabled: The IEEE 1394 A connector is disabled and is not visible to the operating system.
- Enabled: The IEEE 1394 A connector is enabled.

### Integrated Network

Allows you to enable or disable the on-board LAN controller.

- Disabled: Internal LAN is disabled and is not visible to the operating system.
- Enabled: Internal LAN is enabled.

### High Definition Audio

Allows you to enable or disable the internal high definition audio device.

- Disabled: The internal audio device is disabled and is not visible to the operating system.
- Enabled: The internal audio device is enabled.

### Advanced Menu

---

SD Card Reader	Allows you to enable or disable the internal SD card reader.
CPU Turbo Mode	Allows you to enable or disable the Intel CPU turbo mode performance option.
CPU Over-Clocking	Allows you to enable or disable CPU bus clock Over-Clocking <ul style="list-style-type: none"><li>▪ Disabled: CPU bus clock is 133 MHz.</li><li>▪ Enabled: CPU bus clock is between 134 MHz and 166 MHz.</li></ul>
SATA Operation	Allows you to configure the operating mode of the integrated SATA hard drive controller. <ul style="list-style-type: none"><li>▪ ATA: SATA is configured for ATA mode.</li><li>▪ AHCI: SATA is configured for AHCI mode.</li></ul>
SATA HARD DRIVE	Displays the installed SATA hard drive model.

## Advanced Menu

---

### Adapter Warnings

Allows you to choose if the computer should display warning messages when you use certain power adapters. The computer displays these messages if you attempt to use a power adapter that has too little capacity for your configuration.

- Disabled: BIOS will not detect unsupported A/C adapters and will not display any message to screen.
- Enabled : BIOS will detect unsupported A/C adapters and display an error to screen.

### Charger Behavior

Allows you to enable or disable battery charging.

### USB Powershare

Allows you to enable or disable charging of devices plugged into the USB Powershare connector while in Battery Mode.

### Wireless Menu

---

Bluetooth	Allows you to enable or disable the internal Bluetooth device. <ul style="list-style-type: none"><li>• Disabled: The internal Bluetooth device is disabled and is not visible to the operating system.</li><li>• Enabled: The internal Bluetooth device is enabled.</li></ul>
Wireless Network	Allows you to enable or disable the internal wireless device. <ul style="list-style-type: none"><li>• Disabled: The internal wireless device is disabled and is not visible to the operating system.</li><li>• Enabled: The internal wireless device is enabled.</li></ul>
WWAN	Allows you to enable or disable the internal WWAN device.

### Security Menu

---

Supervisor Password	Displays if the supervisor password is clear or set.
User Password	Displays if the user password is clear or set.
Set Supervisor Password	Allows you to set the supervisor password. The supervisor password controls access to the system setup utility.

## Security Menu

---

Set User Password	Allows you to set the user password. The user password controls access to the computer at boot.
Fail Safe	Allows you see if the Phoenix FailSafe™ security software is enabled or disabled. The Phoenix FailSafe software allows you to protect, track, and manage your laptop and your digital files if your laptop is lost or stolen.

## Boot Menu

---

Use the <F5> or <F6> keys to change the boot device priority. You can choose from:

- Hard Drive
- USB Storage
- CD/DVD/BD
- Removal Devices
- Network

### Exit Menu

---

Exit Saving Changes	Allows you to exit System Setup and save your changes to CMOS.
Save Change Without Exit	Allows you remain in System Setup and save your changes to CMOS.
Exit Discarding Changes	Allows you to exit System Setup and load previous values from CMOS for all Setup items.
Load Optimal Defaults	Allows you to load default values for all Setup items.
Discard Changes	Allows you to load previous values from CMOS for all Setup items.

አሁን ለገጽ 4: አገልግሎት ማስተካከል  
ወይንም ማስተካከል ማድረግ

## CHAPTER 4: INSTALLING AND REPLACING COMPONENTS

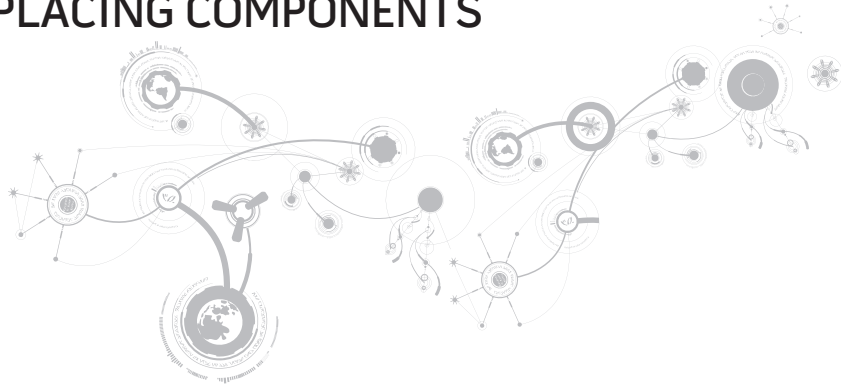

## CHAPTER 4: INSTALLING AND REPLACING COMPONENTS

This chapter provides guidelines and instructions for increasing the processing power and storage space, by upgrading equipment. You can purchase components for your computer at [www.dell.com](http://www.dell.com) or [www.alienware.com](http://www.alienware.com).

 **NOTE:** See the *Service Manual* at [support.dell.com/manuals](http://support.dell.com/manuals) for installation instructions of all serviceable components. Parts purchased from Dell and Alienware will ship with specific replacement instructions.

### Before You Begin

This section provides procedures for removing and installing the components in your laptop. Unless otherwise noted, each procedure assumes that the following conditions exist:

- You have performed the steps in “Turning Off Your Computer” and “Before Working Inside Your Computer” in this section.
- You have read the safety information that shipped with your computer.
- A component can be replaced or—if purchased separately—installed by performing the removal procedure in reverse order.

The procedures in this section may require the following tools:

- Small flat-blade screwdriver
- Phillips screwdriver







## Turning Off Your Computer

 **CAUTION:** To avoid losing data, save and close all open files and exit all open programs before you turn off your laptop.

1. Save and close all open files and exit all open programs.
2. Click **Start**  → **Shut Down**.  
The laptop turns off after the operating system shutdown process finishes.
3. Ensure that the computer and any attached devices are turned off. If your computer and attached devices did not automatically turn off when you shut down your operating system, press and hold the power button for at least 8 to 10 seconds until the computer turns off.

# Before Working Inside Your Computer

Use the following safety guidelines to help protect your computer from potential damage and to help to ensure your own personal safety.

-  **WARNING:** Before working inside your laptop, read the safety information that shipped with your computer. For additional safety best practices information, see the Regulatory Compliance Homepage at [www.dell.com/regulatory\\_compliance](http://www.dell.com/regulatory_compliance).
-  **CAUTION:** Handle components and cards with care. Do not touch the components or contacts on a card. Hold a card by its edges. Hold a component such as a processor by its edges, not by its pins.
-  **CAUTION:** Only a certified service technician should perform repairs on your computer. Damage due to servicing that is not authorized by Dell is not covered by your warranty.
-  **CAUTION:** To avoid electrostatic discharge, ground yourself by using a wrist grounding strap or by periodically touching an unpainted metal surface (such as a connector on the back of the computer).
-  **CAUTION:** When you disconnect a cable, pull on its connector or on its pull-tab, not on the cable itself. Some cables have connectors with locking tabs; if you are disconnecting this type of cable, press in on the locking tabs before you disconnect the cable. As you pull connectors apart, keep them evenly aligned to avoid bending any connector pins. Also, before you connect a cable, ensure that both connectors are correctly oriented and aligned.

**△ CAUTION: To avoid damaging the computer, perform the following steps before you begin working inside the computer.**

1. Ensure that the work surface is flat and clean to prevent the computer cover from being scratched.
2. Turn off your computer (for more information, see “Turning Off Your Computer” on page 57).

**△ CAUTION: To disconnect a network cable, first unplug the cable from your computer and then unplug the cable from the network device.**

3. Disconnect all telephone or network cables from the laptop.
4. Press and eject any installed cards from the Media Card Reader.
5. Disconnect your computer and all attached devices from their electrical outlets.

**△ CAUTION: To help prevent damage to the system board, you must remove the battery from the battery bay before you service the laptop.**

6. Remove the battery from the battery bay (for more information, see “Replacing the Battery Pack” on page 60).
7. Press the power button to ground the system board.

# Replacing the Battery Pack

This battery pack can easily be removed and replaced. Ensure that the laptop is properly shut down before changing the battery pack.

 **CAUTION: To avoid damage to the laptop, use only the battery designed for this particular Alienware laptop. Do not use batteries designed for other Alienware or Dell laptops.**

To remove the battery pack:

1. Follow the instructions in “Before You Begin” on page 56.
2. Shut down the laptop.
3. Turn the laptop over.
4. Loosen the eight captive screws and remove the base cover.

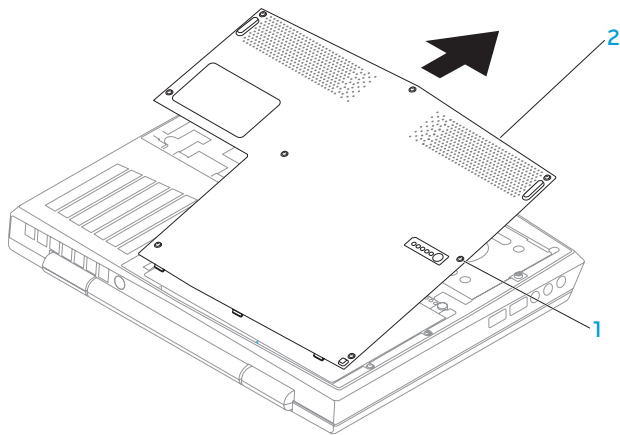

1 captive screws (8)

2 base cover

## CHAPTER 4: INSTALLING AND REPLACING COMPONENTS

5. Remove the two screws that secure the battery pack to the computer base.
6. Disconnect the battery pack cable from the connector on the system board.
7. Lift and slide the battery pack out of the computer.

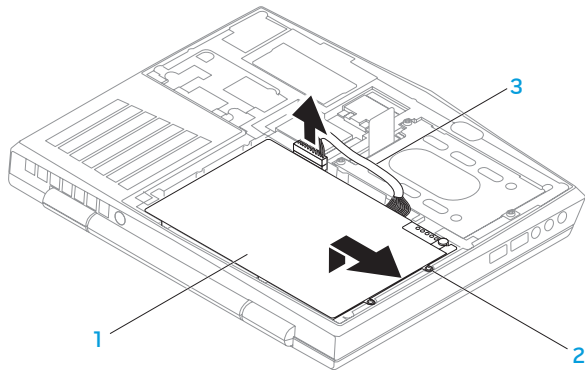

1 battery pack

3 battery pack cable

2 screws (2)

To replace the battery pack, perform the removal steps in reverse order.

## Upgrading or Replacing Memory

Your laptop is equipped with a configurable memory unit. The industry standard JEDEC PC3-8500/PC3-10600 (DDR3) SODIMM memory module connectors are available for memory upgrade. The table below illustrates all the possible ways system memory can be configured.

Memory connector #1	Memory connector #2	Total memory
1 GB	1 GB	2 GB
1 GB	2 GB	3 GB
2 GB	2 GB	4 GB
4 GB	4 GB	8 GB

### Removing the Memory Module(s)

1. Follow the instructions in “Before You Begin” on page 56.
2. Remove the battery (see “Replacing the Battery Pack” on page 60).
3. Use your fingertips to carefully spread apart the memory module connector’s spring-locks until the module pops up.
4. Remove the memory module.

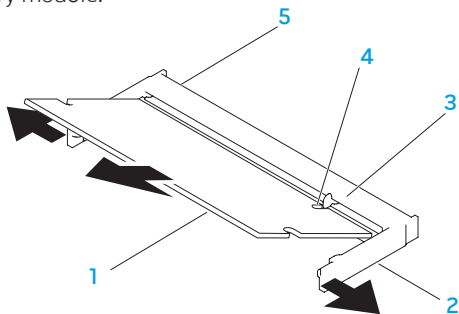



- 1 memory module
- 2 spring locks (2)
- 3 tab

- 4 notch
- 5 memory module connector



To replace the memory modules, perform the removal steps in reverse order. While inserting the memory module into the connector align the notch on the memory module with the tab on the memory module connector.

-  **NOTE:** If you need to install memory modules in two connectors, install a memory module in the lower connector before you install a memory module in the upper connector.
-  **NOTE:** If the memory module is not installed properly, the computer may not boot.

# Upgrading or Replacing the Hard Drive Assembly

Your laptop is equipped with one hard drive socket.

## Removing the Hard Drive

1. Follow the instructions in “Before You Begin” on page 56.
2. Remove the battery (see “Replacing the Battery Pack” on page 60).
3. Loosen the three captive screws on the hard drive assembly.
4. Using the pull-tab, slide and lift the hard drive assembly to disconnect it from the system board connector.
5. Lift the hard-drive assembly out of the computer base.

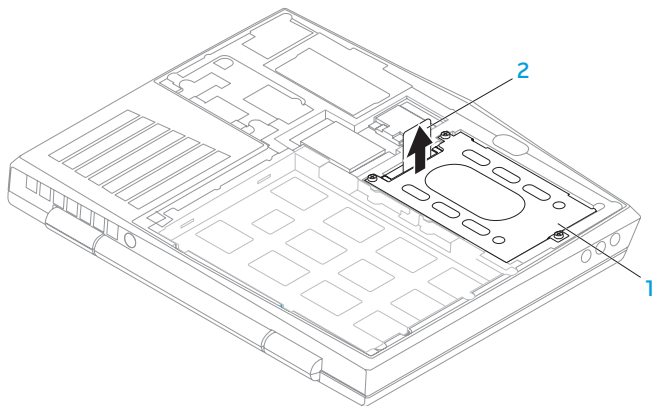

**1** hard drive

**2** pull-tab

6. Remove the four screws that secure the hard drive to the hard drive bracket.
7. Lift the hard drive bracket of the hard drive according to the illustration.

## CHAPTER 4: INSTALLING AND REPLACING COMPONENTS

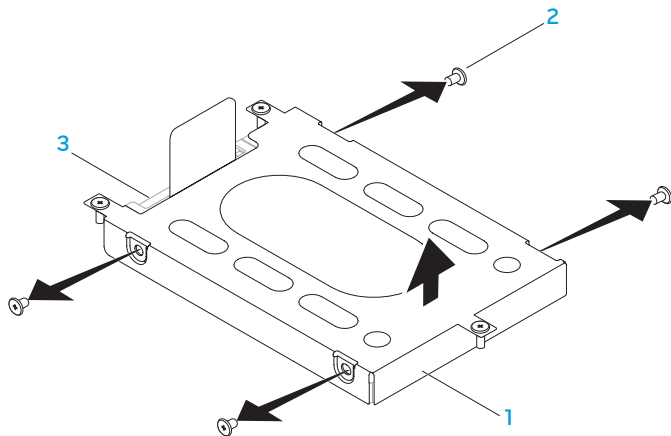

1 hard drive bracket

3 hard drive

2 screws (4)

8. Remove the interposer from the hard drive.

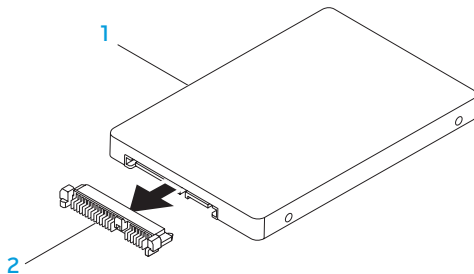

**1** hard drive

**2** interposer

To replace the hard drive, perform the removal steps in reverse order.



ህዝባዊ ግንባታ ለግብርና

## CHAPTER 5: TROUBLESHOOTING



# Basic Hints and Tips

- Computer does not power on: Is your AC adapter cable securely connected to a working electrical outlet? If connected to a power strip, ensure that the strip is actually working.
- Connections: Check all the cables to ensure that there are no loose connections anywhere.
- Power Savings: Ensure that your computer is not in hibernate or standby mode by pressing the power button for less than 4 seconds. The power status light will fade from blue to black while in standby mode; in hibernate mode it will be off.
- Brightness: Check and adjust the brightness of the display by pressing the key combinations <Fn><F4> or <Fn><F5>.
- Display Choice: Press the key combination <Fn><F1> to ensure that the computer is not set to "External Only" display.
- Use only the AC adapter that shipped with your laptop.



## Backup and General Maintenance

- Always backup your important data on a regular basis and keep copies of your operating system and software safe. Do not forget to note the serial numbers if you are storing them outside of their original cases - e.g., in a CD wallet.
- Run maintenance programs as often as you can. You may schedule these programs to run at times when you are not using your computer. You can use those provided with your operating system, or buy more powerful, dedicated programs to do so.
- Write down your passwords and keep them safe (away from your computer). This is especially important if you choose to password-protect your computer's BIOS and operating system.
- Document vital settings such as network, dialup, mail and Internet settings.

### *When troubleshooting your computer, remember the following safety guidelines:*

- Before touching any of the computer's internal components, touch an unpainted portion of the chassis. Doing so will safely discharge any static electricity, which could damage your computer.
- Turn off your computer and any connected peripherals.
- Disconnect any peripherals from your computer.

### *Things to check:*

- Ensure that the AC adapter cable is properly connected between your computer and a grounded, three-prong power outlet. Ensure that the power outlet is working.
- Ensure the UPS or power strip is turned on (if applicable).
- If your peripheral devices (e.g. keyboard, mouse, printer, etc.) are not working, ensure that all connections are secure.
- If any computer components were added or removed before the problem began, check to see if you performed the installation or removal procedures properly.
- If an error message appears on the screen, write down the exact error message prior to calling Alienware Technical Support to aid in diagnosing and resolving your issue.
- If an error occurs in a specific program, see the program's documentation.

# Software Diagnostic Tools

## Pre-Boot System Assessment (PSA)

The computer runs the Pre-boot System Assessment (PSA), a series of initial tests of your system board, keyboard, display, memory, hard drive, etc.

To invoke PSA:

1. Turn on (or restart) your computer.
2. Shut down and restart the laptop. When the Alienware logo appears, press <F12> immediately.

 **NOTE:** If you wait too long and the operating system logo appears, continue to wait until you see the Microsoft® Windows® desktop; then, shut down your computer and try again.

3. Select **Diagnostics** from the menu and press <Enter>.

During the assessment, answer any questions that appear.

- If a failure is detected, the computer stops and beeps. To stop the assessment and restart the computer, press <n>; to continue to the next test, press <y>; to retest the component that failed, press <r>.
- If failures are detected during the Pre-boot System Assessment, write down the error code(s) and contact Alienware (for more information, see “CONTACTING ALIENWARE” on page 109).

## CHAPTER 5: TROUBLESHOOTING

If the Pre-boot System Assessment completes successfully, the following message appears  
"Do you want to run the remaining memory tests? This will take about 30 minutes or more. Do you want to continue? (Recommended)."

If you are experiencing memory issues, press <y>, otherwise press <n>. The following message is displayed: "Pre-boot System Assessment complete."

Press <o> to reboot your computer.

### Alienware® Diagnostics

 **NOTE:** Download Dell Drivers and Utilities from **My DELL Downloads** ([downloadstore.dell.com/media](https://downloadstore.dell.com/media)) and create your own backup media.

If you experience a problem with your Alienware laptop, run the Alienware Diagnostics before you contact Alienware for technical assistance. It is recommended that you print these procedures before you begin.

 **NOTE:** Back up all data before initiating a system recovery.

Review your laptop's configuration information, and ensure that the device that you want to test displays in the system setup program and is active. Start the Alienware Diagnostics from the backup disc.

## Starting Alienware Diagnostics

 **NOTE:** Your computer does not have an internal optical drive. Use an external optical drive or any external storage device for the procedures that involve discs.

1. Insert the drivers and utilities backup disc that you created.
2. Shut down and restart the laptop.  
When the Alienware logo appears, press <F12> immediately.

 **NOTE:** If you wait too long and the operating system logo appears, continue to wait until you see the Microsoft® Windows® desktop; then, shut down your computer and try again.

 **NOTE:** The next steps change the boot sequence for one time only. On the next start-up, the computer boots according to the devices specified in the system setup program.

3. When the boot device list appears, highlight **CD/DVD/CD-RW** and press <Enter>.
4. Select **Boot from CD-ROM** from the menu that appears and press <Enter>.
5. Select **Alienware Diagnostics** from the numbered list. If multiple versions are listed, select the version appropriate for your computer.
6. When the Alienware Diagnostics **Main Menu** appears, select the test you want to run.

 **NOTE:** Write down any error codes and problem descriptions exactly as they appear and follow the instructions on the screen.

7. After all tests have completed, close the test window to return to the Alienware Diagnostics **Main Menu**.
8. Remove the backup disc, then close the **Main Menu** window to exit the Alienware Diagnostics and restart the computer.

# Answers to Common Problems

## System

### The computer fails the POST

The POST (Power On Self Test) tests the computer, ensuring that it meets the necessary system requirements and that all hardware is working properly before starting the remainder of the boot process. If the computer passes the POST, the computer will continue to start normally. However, if the computer fails the POST, the computer will generate a single beep to indicate a general failure and an error message will be displayed. For assistance, contact Alienware Technical Support (see "CONTACTING ALIENWARE" on page 109).

## The computer stops responding or a solid blue screen appears

 **CAUTION:** You might lose data if you are unable to perform an operating system shutdown.

If you are unable to get a response by pressing a key on your keyboard or moving your mouse, press and hold the power button for at least 6 seconds until the computer turns off, then restart your computer.

 **NOTE:** The `chkdsk` program may run when you restart the computer. Follow the instructions on the screen.

## A program stops responding or crashes repeatedly

**End the program:**

1. Press <Ctrl><Shift><Esc> simultaneously.
2. Click the **Applications** tab and select the program that is no longer responding.
3. Click **End Task**.

**Check the software documentation.**

**If necessary, uninstall and then reinstall the program.**

### A program is designed for an earlier version of Microsoft® Windows®

#### Run the Program Compatibility Wizard:

The **Program Compatibility Wizard** configures a program so that it runs in an environment similar to an earlier version of Microsoft Windows operating system environments.

1. Click **Start**  → **Control Panel** → **Programs** → **Programs and Features** → **Use an older program with this version of Windows**.
2. In the welcome screen, click **Next**.  
Follow the instructions on the screen.

### Other software problems

#### Back up your files immediately

Use a virus-scanning program to check the hard drive, or CDs

Save and close any open files or programs and shut down your computer through the Start menu



**Scan the computer for spyware:**

If you are experiencing slow computer performance, you frequently receive pop-up advertisements, or you are having problems connecting to the Internet, your computer might be infected with spyware. Use an anti-virus program that includes anti-spyware protection (your program may require an upgrade) to scan the computer and remove spyware.

**Run the PSA Diagnostics:**

If all tests run successfully, the error condition is related to a software problem.

**Check the software documentation or contact the software manufacturer for troubleshooting information:**

- Ensure that the program is compatible with the operating system installed on your computer.
- Ensure that your computer meets the minimum hardware requirements needed to run the software. See the software documentation for information.
- Ensure that the program is installed and configured properly.
- Verify that the device drivers do not conflict with the program.
- If necessary, uninstall and then reinstall the program.

## Hard Drive Problems

### Allow the computer to cool before turning it on

A hot hard drive may prevent the operating system from starting. Try allowing the computer to return to room temperature before turning it on.

### Run Check Disk

1. Click **Start**  → **Computer**.
2. Right-click **Local Disk C:**.
3. Click **Properties** → **Tools** → **Check Now**.  
If the **User Account Control** window appears, click **Continue**.

Follow the instructions on the screen.

## Memory

### Memory errors detected on startup

- Check memory modules for correct seating and orientation. Reseat the memory modules if applicable (see “Upgrading or Replacing Memory” on page 63).
- Computers using a dual-channel memory configuration require that memory modules be installed in pairs. If you require assistance, contact Alienware Technical Support (for more information, see “CONTACTING ALIENWARE” on page 109).

## Display

### If the display is blank

 **NOTE:** If you are using a program that requires a higher resolution than your computer supports, it is recommended that you attach an external monitor to your computer.

#### **The computer may be in a power saving mode:**

Press a key on the keyboard or press the power button to resume normal operation.

#### **Switch the video image:**

If your computer is attached to an external monitor, press <Fn><F1> to switch the video image to the display.

### Power

#### When you press the power button, the computer does not turn on

- If the AC adapter cable is connected to a surge protector or UPS, ensure that the surge protector or UPS is securely connected to an electrical outlet, is switched on and is working correctly.
- Check that the wall outlet is working properly by testing another device such as a radio or lamp that you know works. If the wall outlet is not working, contact an electrician or your power company for further assistance.
- If the problem persists, contact Alienware support (see “CONTACTING ALIENWARE” on page 109).

የአዲስ አበባ ዩኒቨርሲቲ

## CHAPTER 6: SYSTEM RECOVERY



# Recovery Options

Your computer has the following system recovery options:

- **Operating System Reinstallation Disc** — Contains operating system installation media.
- **Dell DataSafe Local** — Your computer is pre-installed with Dell DataSafe Local (see “Dell DataSafe Local Backup” on page 87).
- **Dell DataSafe Online** — Dell DataSafe Online is an online data backup service (see “Dell DataSafe Online Backup” on page 89).
- **System Drivers** — You can download the latest drivers for your computer from [support.dell.com](http://support.dell.com).
- **System Applications** — Some of the software that is pre-installed on your computer does not include a backup CD/DVD. This software is available at **My Dell Downloads** ([downloadstore.dell.com/media](http://downloadstore.dell.com/media)).

 **NOTE:** My Dell Downloads may not be available in all regions.

## Dell DataSafe Local Backup

Dell DataSafe Local Backup is a backup and recovery application that can restore your computer if you lose data due to a virus attack, accidentally delete critical files or folders, or if the hard drive crashes.

 **NOTE:** A USB key with a minimum capacity of 8 GB is required to create a full system backup.

This application allows you to:

- Restore files and folders
- Restore your hard drive to the operating state it was in when you purchased your computer, without erasing the existing personal files and data

To schedule backups:

1. Double-click the Dell DataSafe Local Backup icon  on the taskbar.
2. Choose **Full System Backup** to create and schedule automatic backup of all the data in your computer.

## CHAPTER 6: SYSTEM RECOVERY

To restore data:

1. Turn off your computer.
2. Disconnect all the devices connected to the computer (such as USB drive, printer, etc.) and remove any recently added internal hardware.

 **NOTE:** Do not disconnect the monitor, keyboard, mouse, and the power cable.

3. Turn on your computer.
4. When the Alienware logo appears, press <F8> several times to access the **Advanced Boot Options** window.

 **NOTE:** If you wait too long and the operating system logo appears, continue to wait until you see the Microsoft® Windows® desktop; then, shut down your computer and try again.

5. Select **Repair Your Computer**.
6. Select **Dell Factory Image Recovery and DataSafe Options** and follow the instructions on the screen.

 **NOTE:** The restoration process may take an hour or more depending on the size of the data to be restored.

 **NOTE:** For more information on Dell DataSafe Local Backup, see knowledge base article 353560 at [support.dell.com](http://support.dell.com).



## Dell DataSafe Online Backup

 **NOTE:** Dell DataSafe Online Backup may not be available in all regions.

 **NOTE:** A broadband connection is recommended for fast upload/download speeds.

Dell DataSafe Online is an automated backup and recovery service that helps protect your data and other important files from catastrophic incidents like theft, fire, or natural disasters. You can access the service on your computer using a password-protected account.

For more information, go to **delldatasafe.com**.

To schedule backups:

1. Double-click the Dell DataSafe Online icon  on the taskbar.
2. Follow the instructions that appear on the screen.



አዲስ አበባ ዩኒቨርሲቲ ፡ የኢንፎርሜሽን ቴክኖሎጂ

## CHAPTER 7: SPECIFICATIONS



### Computer Model

---

Alienware M11x-R2

### Dimensions

---

Height (front and back) 32.7 mm (1.29 inches)

Width 285.7 mm (11.25 inches)

Depth 233.3 mm (9.19 inches)

Weight with 8-cell battery  
(starting at) 2.0 kg (4.4 lbs)

**NOTE:** The weight of your laptop will vary depending on the configuration ordered and the manufacturing variability.

## Processor and System Chipset

---

Processor	Intel® Core™ i3 Intel Core i5 Intel Core i7
L2 cache	256 KB
L3 cache	up to 4 MB
Bus clock	133 Mhz
System chipset	Intel QS57
SDRAM bus width	one or two 64-bit channels of DDR3 memory up to 1333 MHz
Processor address bus width	32 bits
Processor data width	64 bits
BIOS EPROM	8 Mbit
Graphics bus	PCIe x16 bus
PCI bus	32 bits

## CHAPTER 7: SPECIFICATIONS

### Memory

---

Connectors	two internally-accessible DDR3 SODIMM sockets
Capacities	1 GB, 2 GB, and 4 GB
Memory type	1066 MHz and 1333 MHz (operates at 800 Mhz) dual-channel DDR3 configurations
Memory configurations possible	2 GB, 3 GB, 4 GB, and 8 GB

### IEEE 1394 A

---

IEEE 1394 A controller	JMicron JMB380
IEEE 1394 interface	compliant with standard IEEE 1394a-2000 specification

## Ports and Connectors

---

Network adapter	one RJ45 connector
USB	three 4-pin USB 2.0-compliant connectors, including one USB PowerShare connector
HDMI	one 19-pin connector
DisplayPort	one 20-pin connector
Audio	two audio output/headphone connectors and one audio input/microphone connector
3-in-1 Media Card Reader	one combo connector
SIM card	one SIM card slot
IEEE 1394	one 4-pin serial connector

## Communications

---

Network adapter	10/100/1000 Mbps Ethernet LAN on system board
Wireless	<ul style="list-style-type: none"><li>• WLAN Mini-Card (half Mini-Card slot)</li><li>• WWAN Mini-Card (full Mini-Card slot) (optional)</li><li>• integrated Bluetooth® module (optional)</li></ul>

## CHAPTER 7: SPECIFICATIONS

### Video

---

Video controller

Integrated

Intel QS57

Discrete

Nvidia NV11P-GS1

Video memory

Integrated

dynamic based on system memory capacity

Discrete

1 GB

External display support

HDMI and DisplayPort

### Audio

---

Controller

Intel HDA

Speaker

single 8-ohms speakers in both the left and right speaker assembly

Internal speaker amplifier

up to 1 W per channel; up to 2 W total power

Internal microphone support

single digital microphone in camera assembly

Volume controls

program menus and keyboard media function keys



### Hard-Drive Storage

---

Interface	SATA
Number of hard drives	one
Hard drive	2.5 inch SATA hard drive
Type	standard portable and solid-state hard-drives

### Cards Supported

---

Media cards	<ul style="list-style-type: none"><li>▪ Secure Digital (SD) memory card</li><li>▪ MultiMedia Card (MMC)</li><li>▪ Memory Stick PRO</li></ul>
Video cards	<ul style="list-style-type: none"><li>▪ Intel QS57</li><li>▪ Nvidia GeForce GT 335M (discrete)</li></ul>

### Display

---

Type	11.6 inch HD TrueLife, WLED
Maximum resolution	1366 x 768
Dimensions	
Height	144 mm (5.67 inches)
Width	256.12 mm (10.08 inches)
Diagonal	293.83 mm (11.57 inches)
Refresh rate	60 Hz
Operating angle	0° (closed) to 140°
Pixel pitch	0.2550 mm
Controls	brightness can be controlled through keyboard shortcuts

**Keyboard (Backlit)**

---

Number of keys	82 (Korea, U.S, and Canada); 83 (Europe); 86 (Japan)
Backlight color	RGB; colors can be changed by invoking the AlienFX® application in the Alienware Command Center. For information, see your <i>Mobile Manual</i> .

**Touch Pad**

---

X/Y position resolution (graphics table mode)	240 cpi
Size	
Height	71.7 mm (2.82 inches) sensor-active area
Width	34.0 mm (1.33 inches) rectangle

**Camera**

---

Camera resolution	1.3 megapixel
Video resolution	640 x 480 at 30 fps
Diagonal viewing angle	63.13° +/- 5%

### Battery

---

8-cell “smart” lithium ion (63 Whr)

Height 11.2 mm (0.44 inches)

Width 173 mm (6.81 inches)

Depth 109.4 mm (4.31 inches)

Weight 0.43 kg (0.94 lb)

Voltage 14.8 V

Operating time battery operating time varies depending on operating conditions and can be significantly reduced under certain power-intensive conditions.

Life span (approximate) 300 discharge/charge cycles

Temperature range

Operating 0° to 50°C (32° to 122°F)

Storage -20° to 60°C (-4° to 140°F)

Coin-cell battery CR-2032

**AC Adapter**

---

Type	90 W
Input voltage	100-240 VAC
Input current (maximum)	1.5 A
Input frequency	50-60 Hz
Output current	4.62 A (continuous)
Output power	90 W
Rated output voltage	19.5 VDC
Temperature range	
Operating	0° to 40°C (32° to 104°F)
Storage	-40° to 70°C (-40° to 158°F)
Connector types	
DC connector	3-pin, 7.4 mm plug
AC connector	3-pin – C5

### Computer Environment

---

#### Temperature range

Operating	0° to 35°C (32° to 95°F)
Storage	-40° to 65°C (-40° to 149°F)

#### Relative humidity (maximum)

Operating	10% to 90% (non-condensing)
Storage	10% to 95% (non-condensing)

#### Maximum vibration (using a random vibration spectrum that simulates user environment)

Operating	0.66 GRMS
Storage	1.3 GRMS

#### Maximum shock (Measured with hard drive in operating status and a 2-ms half-sine pulse for operating. Also measured with hard drive in head-parked position and a 2-ms half-sine pulse for storage)

Operating	110 G
Storage	160 G

## Computer Environment

---

### Altitude (maximum)

Operating

–15.2 to 3048 m (–50 to 10,000 ft)

Storage

–15.2 to 10,668 m (–50 to 35,000 ft)

Airborne contaminant level

G2 or lower as defined by ISA-S71.04-1985







# APPENDIX



# GENERAL AND ELECTRICAL SAFETY PRECAUTIONS

## Computer Setup

- Read all instructions marked on the product and in the documentation before operating your computer.
- Retain all safety and operating instructions.
- Never use this product near water or a heat source.
- Only set-up the computer on a stable work surface.
- Only operate the computer using the power source type indicated on the rating label.
- Never block or cover any openings or fans in the computer case. These are required for ventilation.
- Never insert objects of any kind into the ventilation openings.
- Ensure that your computer is properly grounded when in use.
- Do not attempt to connect your computer into an outlet that is not properly grounded.
- If an extension cord is used with your computer, ensure that the total ampere rating on the computer does not exceed the maximum rating on the extension cord.

## Computer Use

- Route the power cable and all cables away from where people might walk or trip over them. Do not allow anything to rest on the power cable.
- Do not spill anything on or into your computer.
- To avoid electrical shock, always disconnect all power, modem and any other cables from the wall outlets before handling the computer.

## Electrostatic Discharge (ESD) Warning

Electrostatic Discharge (ESD) can cause damage to internal system components if precautions are not taken. ESD is caused by static electricity and the damage caused is usually permanent.

Computer technicians wear a special wrist-strap that grounds them to the computer's case to prevent ESD damage. You can reduce the chances of ESD damage by doing the following:

- Turn off your computer's power and wait several minutes before starting to work.
- Ground yourself by touching the case of the computer.
- Avoid walking around while replacing items inside the case, especially if you are on a carpet or during low temperature and low humidity.
- Touch only those items which must be replaced.

## APPENDIX

- If you have to remove peripheral cards for any reason, place them on the portion of the computer's case that was removed. Do not touch the edge connectors at the bottom of the card that connect to the system board.

### General Safety Precautions

- **Mechanical Shock:** Your computer should never be subjected to severe mechanical shocks. Careless handling of your computer may cause damage. Mechanical Shock is not covered by the warranty.
- **Electrical Shock:** If you do not open up your computer, there is nothing to worry about. Your computer protects itself against most irregularities in the power source.

### When You Should Contact Alienware

- The battery, power cable or connector is damaged.
- Your computer has had liquid spilled into it.
- Your computer was dropped or the case was damaged.
- Normal operation of the computer does not occur when the operating instructions are followed.

### Replacement Components or Accessories

It is only advised to use replacement parts or accessories recommended by Alienware.

## CONTACTING ALIENWARE

For customers in the United States/Canada, call 1-800-ALIENWARE.

 **NOTE:** If you do not have an active Internet connection, you can find contact information on your purchase invoice, packing slip, bill, or Dell product catalog.

Dell provides several online and telephone-based support and service options. Because availability varies by country and product, some services may not be available in your area.

To contact Dell for sales, technical support, or customer service issues:

1. Visit **[www.dell.com/contactdell](http://www.dell.com/contactdell)**.
2. Select your country or region.
3. Select the appropriate service or support link based on your need.
4. Choose the method of contacting Dell that is convenient for you.

# Websites

You can learn about Alienware products and services on the following websites:

- [www.dell.com](http://www.dell.com)
- [www.dell.com/ap](http://www.dell.com/ap) (Asian/Pacific countries only)
- [www.dell.com/jp](http://www.dell.com/jp) (Japan only)
- [www.euro.dell.com](http://www.euro.dell.com) (Europe only)
- [www.dell.com/la](http://www.dell.com/la) (Latin American and Caribbean countries)
- [www.dell.ca](http://www.dell.ca) (Canada only)

You can access Alienware Support through the following websites:

- [support.dell.com](http://support.dell.com)
- [support.jp.dell.com](http://support.jp.dell.com) (Japan only)
- [support.euro.dell.com](http://support.euro.dell.com) (Europe only)
- [support.la.dell.com](http://support.la.dell.com) (Argentina, Brazil, Chile, Mexico)

## Information for NOM, or Official Mexican Standard (Only for Mexico)

The following information is provided in the device(s) described in this document in accordance with the requirements of the Official Mexican Standard (NOM):

Importer:

Dell México S.A. de C.V.  
Paseo de la Reforma 2620 - Flat 11°  
Col. Lomas Altas  
11950 México, D.F.

<b>Regulatory Model Number</b>	<b>Voltage</b>	<b>Frequency</b>	<b>Electricity Consumption</b>	<b>Output Voltage</b>	<b>Output Intensity</b>
P06T	100-240 VAC	50-60 Hz	1.50 A	19.50 VDC	3.34 A

For details, read the safety information that shipped with your computer.

For additional safety best practices information, see the Regulatory Compliance Homepage at [www.dell.com/regulatory\\_compliance](http://www.dell.com/regulatory_compliance).

